

KNL6 ... KNL18

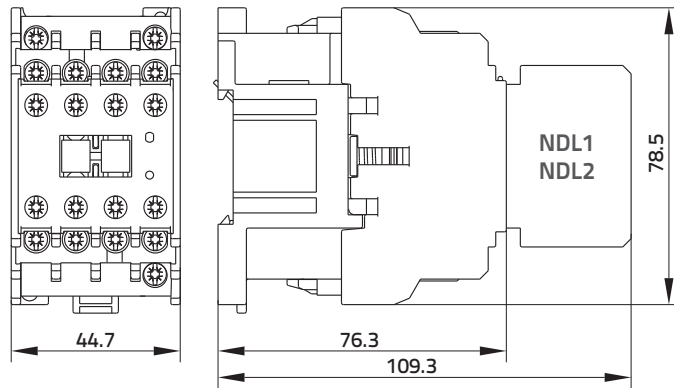

KNL6 ... KNL38 - drilling plan

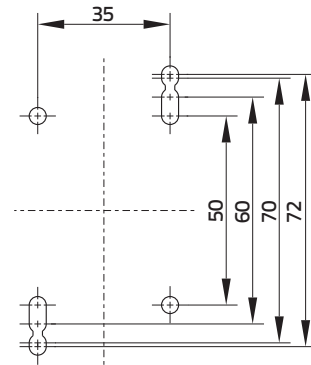

KNL22 ... KNL38

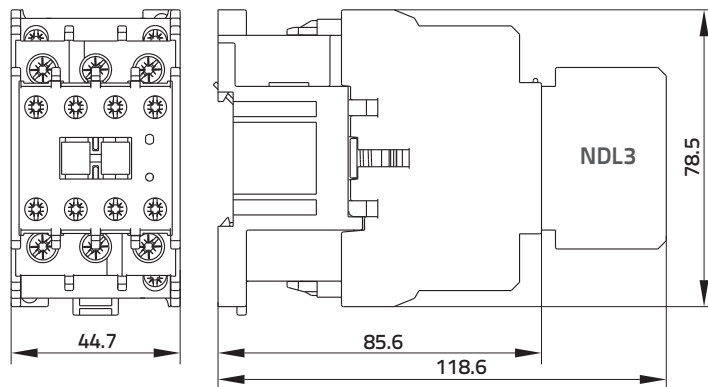

NDL1, NDL2, NDL3

Two and four-pole snap-on auxiliary switch blocks (mounting on a basic contactor)

- NDL1 - for KNL6(G)
- NDL2 - for KNL9(G) - KNL18(G)
- NDL3 - for KNL22(G) - KNL38(G)

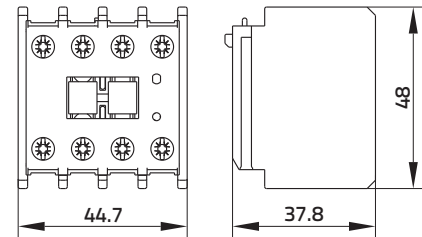

NPL1, NPL2

Single pole snap-on auxiliary switch block (for side mounting + push button)

- NPL1 - for KNL9(G) - KNL18(G)
- NPL2 - for KNL22(G) - KNL38(G)

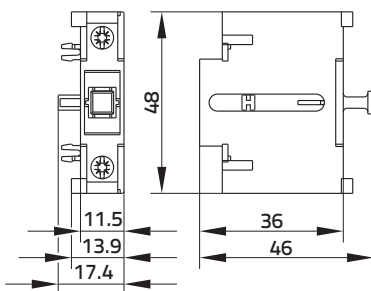

RC suppressor

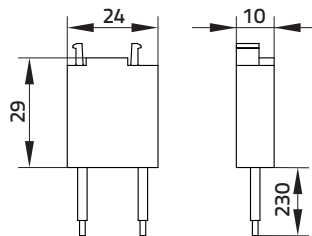

MBL mechanical interlock

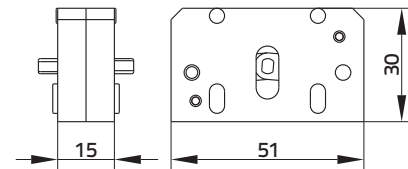

NT identification plate

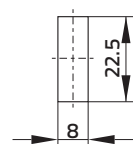

DZ distance spacer

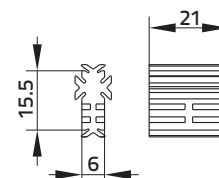

Contactors KN6(G)-KNL38(G)

Dimensions

KNL9-KNL18 + NPL1

KNL22-KNL38 + NPL2

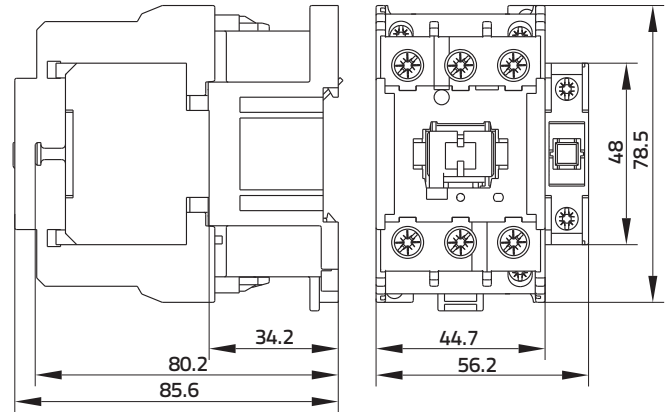
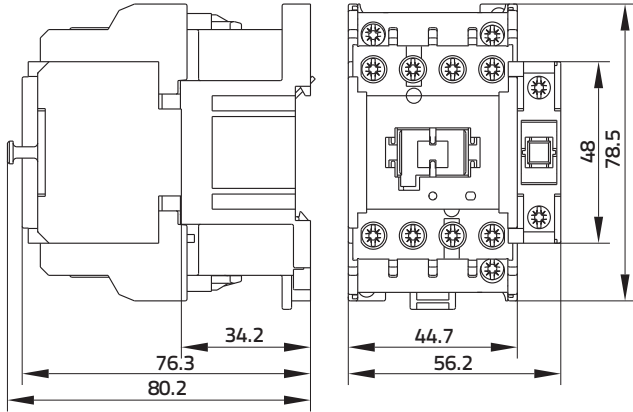

KNL22G-KNL38G + NPLG

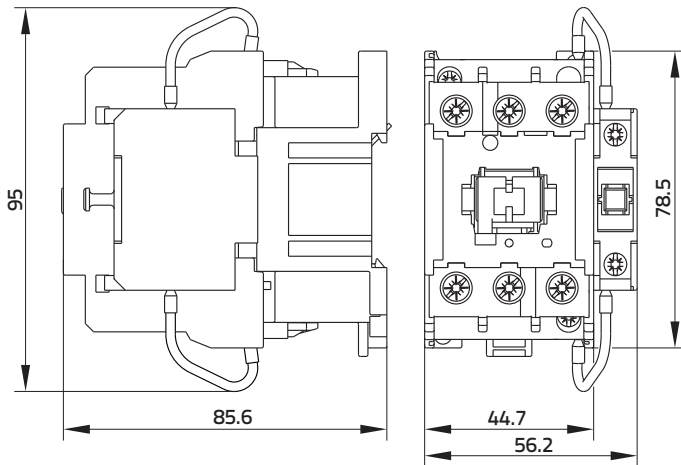

KNL22G-KNL38G + NDLG

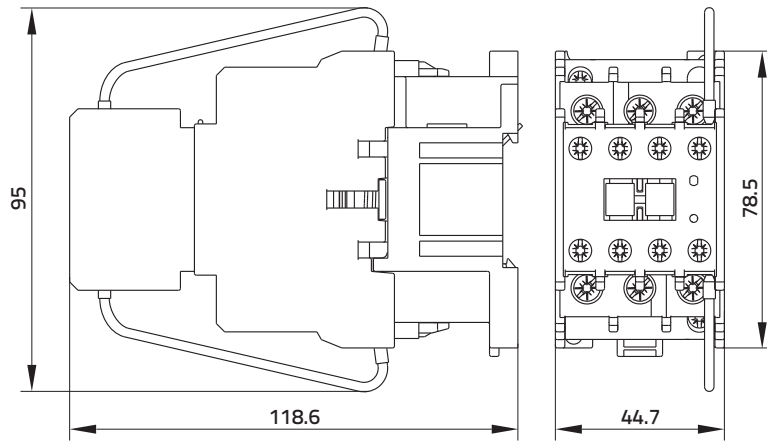

KNL6 ... KNL38 - drilling plan

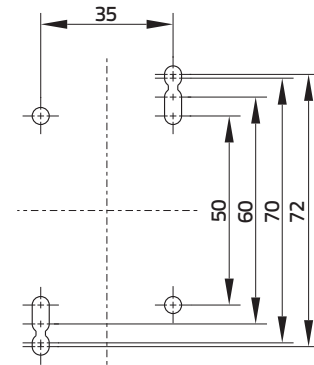

KNL6 ... KNL18 + BR16

Contactor + thermal overload relay

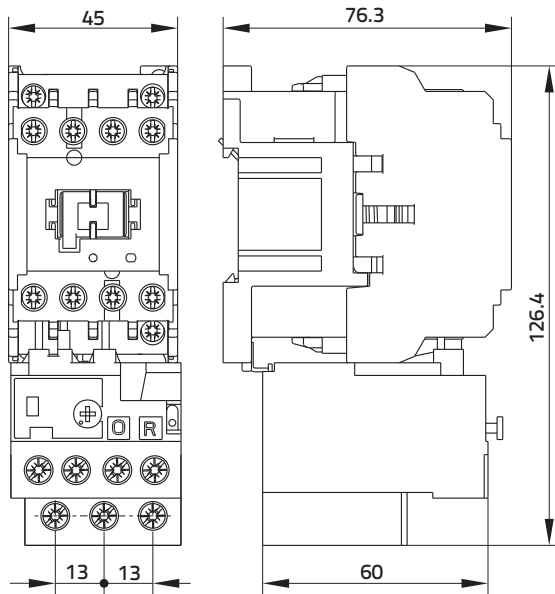

KNL22 ... KNL38 + BR30

Contactor + thermal overload relay

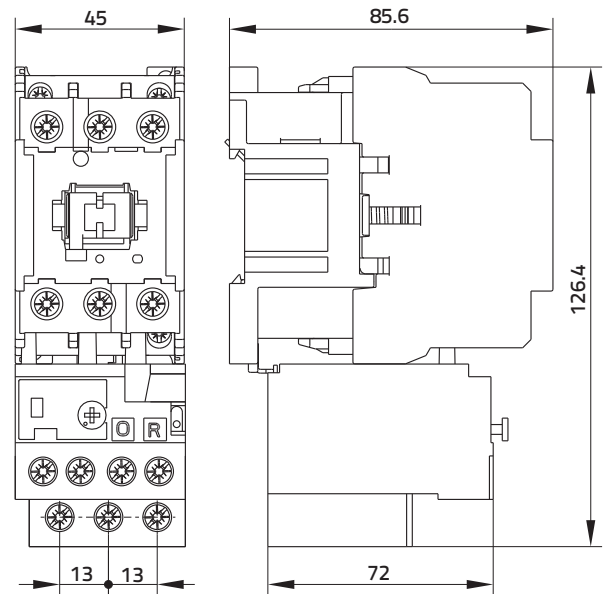

BR16 thermal overload relay

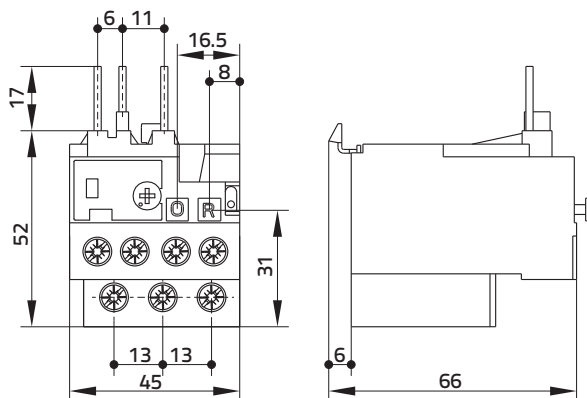

BR30 thermal overload relay

